

DOMINO Series Connectors

Hot-Plug High Current Modular Power Connectors

Key Features

- Modular construction
- Blind mating
- High current CROWN BAND contacts
- Logic/Signal
- Locking system
- Uses ELCON Drawer contacts

Typical Applications

- Power Supplies
- Telecommunications
- Automatic Test Equipment
- Computer Hardware
- Process Control
- Uninterruptible Power Systems
- All DOMINO Products in this section are RoHS compliant

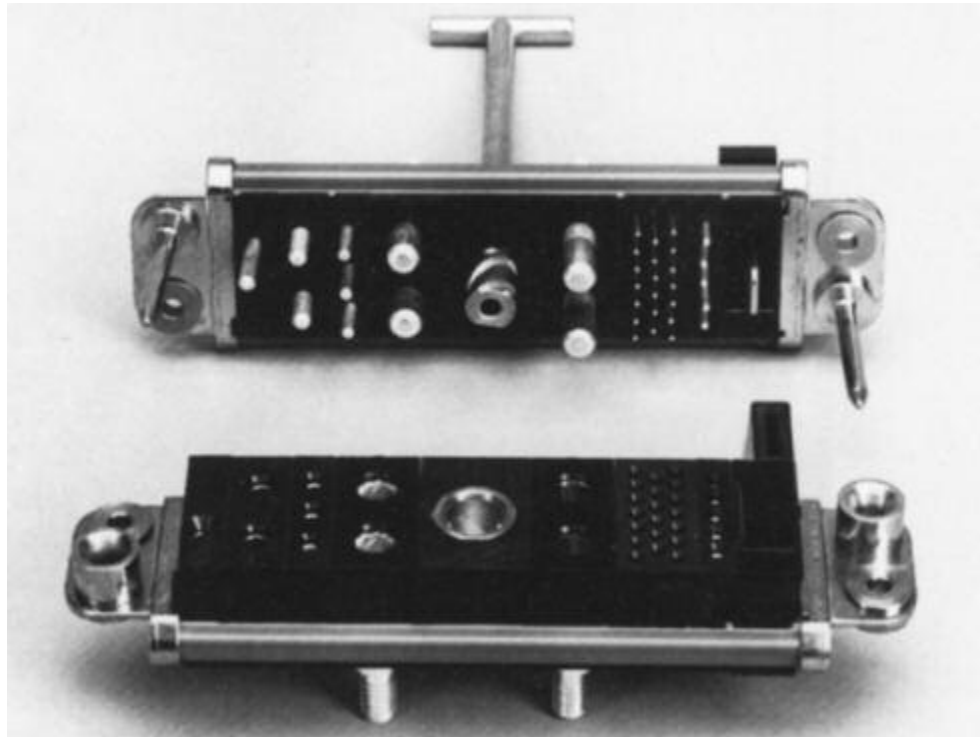

The ELCON DOMINO Connector System is a modular high-current connector system consisting of interchangeable modules which can provide AC, DC, logic and signal, float mounting, and pin sequencing. All DOMINO modules incorporate CROWN BAND technologies, tried and tested under the most arduous conditions. The high current capabilities virtually eliminate the need for bussing or splitting current, with resulting space savings and economies.

The DOMINO connector system allows the user to configure a connector specific to an application, from off-the-shelf components. It can be purchased as separate modules and assembled by the user, but is more generally ordered as a

connector assembly using an assembly part number which Tyco Electronics assigns to a specific configuration. Consult Tyco Electronics for assistance in laying out a new connector. If required, DOMINO connector assembly is simple: once the locking rails are cut to size, the only tool required is a Phillips screwdriver for tightening the end-caps.

Most DOMINO contacts are the same as used in ELCON Drawer connectors. Modules A through E and R are sold as housings with retention clips; the contacts are ordered separately. See page 79 for available contact options and plating information, page 66 for tooling. Modules K, L, and M are sold pre-loaded with contacts. DOMINO assemblies are shipped complete with contacts.

The DOMINO system is ideal for use with hot-pluggable power supplies of the type employed for load-sharing and/or redundant power for computer systems. Current interruption capability is standard in the L module and an available option in the A module.

The CROWN BAND contact is a small louvered cylindrical receptacle of Beryllium Copper. Manufactured on progressive dies to allow consistent, even insertion and withdrawal forces, its design ensures maximum surface contact area for minimum voltage drop and minimum heat generation. CROWN BAND contacts also provide excellent shock and vibration resistance.

DOMINO Series Connectors (Continued)

A Modules — 3 x #12 Power Contacts, Hot-Plug option available

Note: Supplied without contacts. Crimp insertable/removable, PCB insertable/non-removable

Specifications: Contact rating 35 Amps UL, 20 Amps CSA, 250V; Hot-plug 35 Amps UL, 30 Amps CSA, 120 V ac, 50 cycles; Fully loaded module nominal forces: insertion 9.2 lbs, extraction 5.5 lbs (Hot-plug insertion 11.5 lbs, extraction 6.4 lbs)

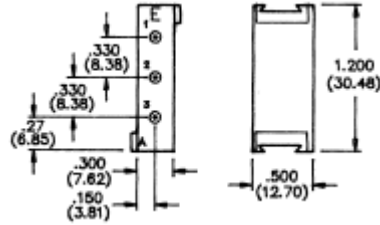

Pin Housing
(without contacts)
Part Number 1648461-1

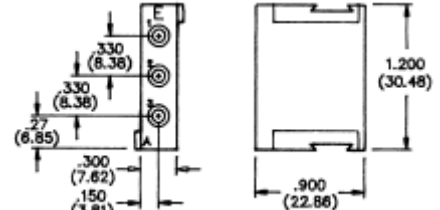

Socket Housing
(without contacts)
Part Number 1648466-1

B Modules — 2 x #8 Power Contacts

Note: Supplied without contacts. Crimp insertable/removable, PCB insertable/non-removable

Specifications: Contact rating 75 Amps UL, 40 Amps CSA, 250V; Fully loaded module nominal forces: insertion 6.7 lbs, extraction 3.9 lbs

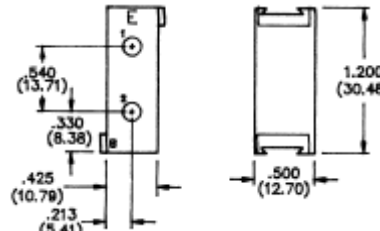

Pin Housing
(without contacts)
Part Number 1648462-1

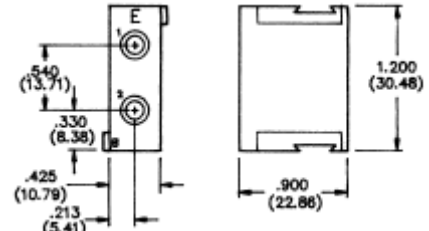

Socket Housing
(without contacts)
Part Number 1648467-1

C Modules — 20 x #20 Signal Contacts

Note: Supplied without contacts. Crimp insertable/removable, PCB insertable/non-removable

Specifications: Contact rating 5 Amps UL, 4 Amps CSA, 125V; Fully loaded module nominal forces: insertion 2.4 lbs, extraction 2.6 lbs

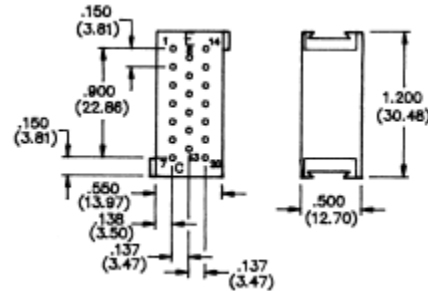

Pin Housing
(without contacts)
Part Number 1648463-1

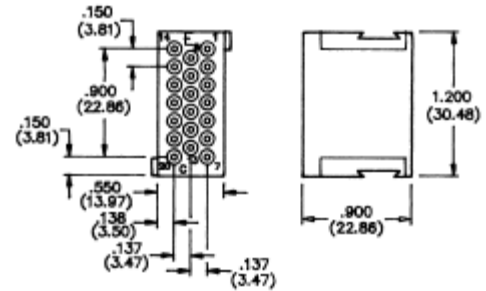

Socket Housing
(without contacts)
Part Number 1648468-1

D Module — 5 x #16 Power Contacts

Note: Supplied without contacts. Crimp insertable/removable, PCB insertable/non-removable

Specifications: Contact rating 15 Amps UL, 10 Amps CSA, 125V; Fully loaded module nominal forces: insertion 18.6 lbs, extraction 13.0 lbs

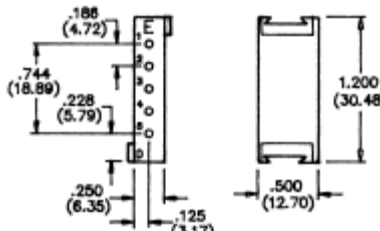

Pin Housing
(without contacts)
Part Number 1648464-1

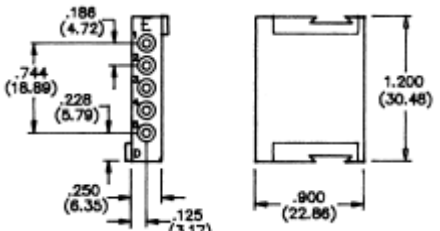

Socket Housing
(without contacts)
Part Number 1648469-1

Note: All part numbers are RoHS compliant.

DOMINO Series Connectors (Continued)

E Modules — 14 x #16 Power Contacts

Note: Supplied without contacts. Crimp insertable/removable, PCB insertable/non-removable

Specifications: Contact rating 15 Amps UL, 10 Amps CSA, 125V; Fully loaded module nominal forces: insertion 43.1 lbs, extraction 33.7 lbs

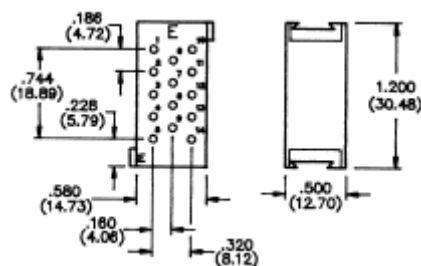

Pin Housing
(without contacts)
Part Number 1648465-1

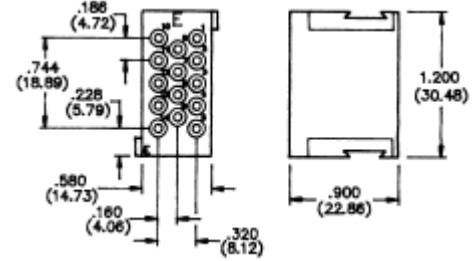

Socket Housing
(without contacts)
Part Number 1648470-1

G Modules - Non-electrical Guide Module

Note: May be turned through 180 in the horizontal plane

Specifications: Guide pin type 303 Stainless Steel, passivated

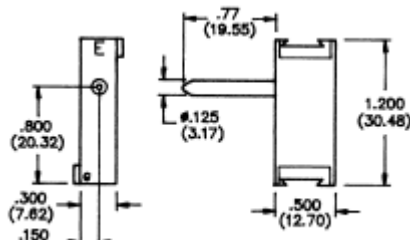

Guide Pin
Part Number 1648505-1

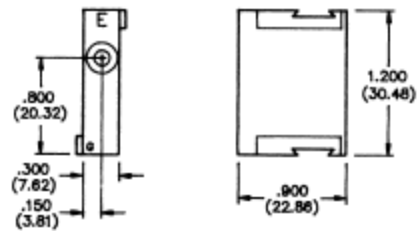

Guide Socket
Part Number 1648473-1

J Modules — Jackscrew Locking Module

Note: Select socket side to match desired orientation of T-handle in locked position

Specifications: Corrosion resistant Steel

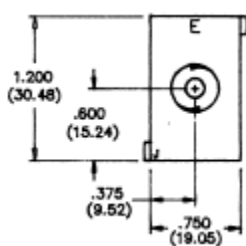

Pin Side
4.20" T-Handle Part
Number 6648482-1

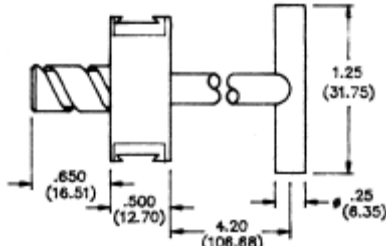

Pin Side
Screwdriver Slot
Part Number 6648485-1

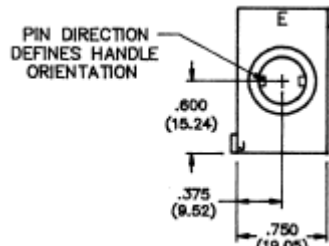

Parallel Socket Side
Part Number 6650679-1

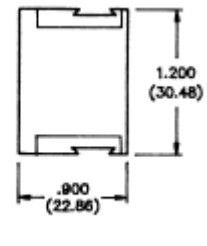

Perpendicular Socket Side
Part Number 6650680-1

K Modules — Electrically Active Ground/Guide Module

Note: May be turned through 180 in the horizontal plane. Use Crimp Tool PN 1766453-1

Specifications: Contact rating 40 Amps UL, 15 Amps CSA, 250V; Fully loaded module nominal forces: insertion 3.0 lbs, extraction 1.3 lbs

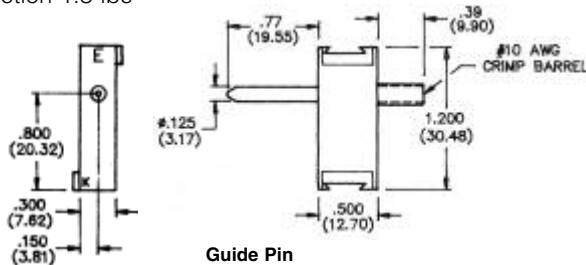

Guide Pin
10 AWG Crimp
Part Number 6648508-1

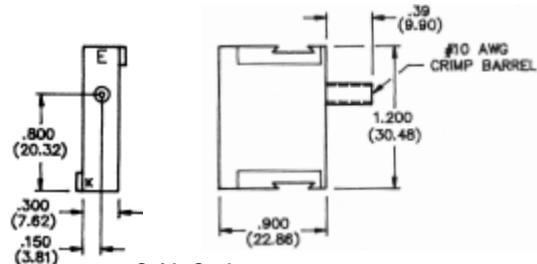

Guide Socket
10 AWG Crimp
Part Number 6648476-1

Note: All part numbers are RoHS compliant.

DOMINO Series Connectors (Continued)

L Modules — Hot-Plug Flat Blade Contact, Crown Socket

Note: Pin and socket modules may be assembled within either pin or socket side connector for reverse polarization. Standard blade length, dim A = .400"; premate blade length, dim A = .525" Use Crimp Tool PN 1766453-1

Specifications: Agency approved for 50 Cycles of current interruption; contact rating 30 Amps UL/CSA, 250V and 55 Amps UL, 30 Amps CSA, 72 V dc; Fully loaded module nominal forces: insertion 4.2 lbs, extraction 3.7 lbs

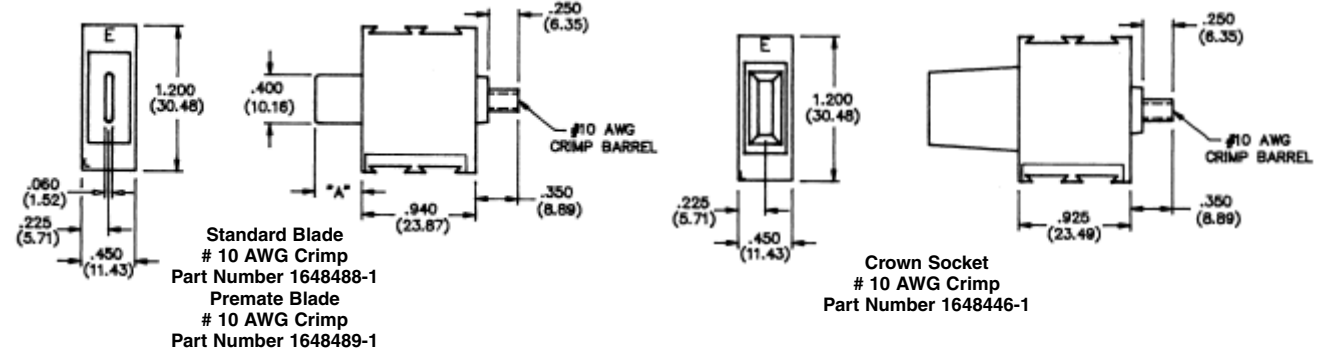

M Modules — Pre-installed Dual In-Line Crown Pin & Socket

Specifications: Contact rating 125 Amps UL/CSA, 250V; Fully loaded module nominal forces: insertion 14.9 lbs, extraction 9.8 lbs

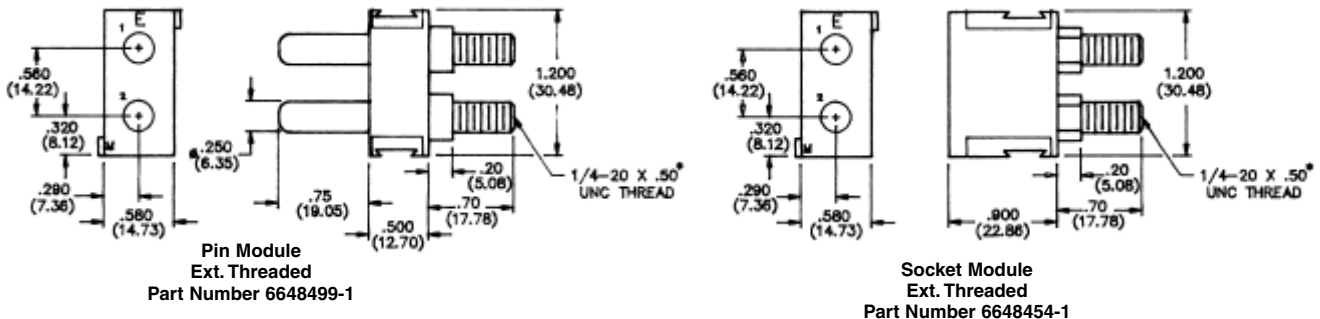

Recommended torque value 40 lb.in (4.52 N.m)

R Modules — 2 x 1/4" Power Contacts

Note: Supplied without contacts; available contacts: Crimp insertable/removable, Ext. Threaded insertable/non-removable, consult Tyco Electronics for contact part numbers and available Double Crown option

Specifications: Contact rating 150 Amps UL, 110 Amps CSA, 250V; Fully loaded module nominal forces: insertion 9.4 lbs, extraction 6.0 lbs



Spacer Module — Non-electrical

Note: any module may be ordered without contacts for use as spacers; consult factory for options and part numbers.

Note: All part numbers are RoHS compliant.

DOMINO Series Connectors (Continued)

DOMINO Assembly
Mounting Accessories

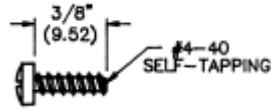

Screw Part Number 1766829-1, Steel

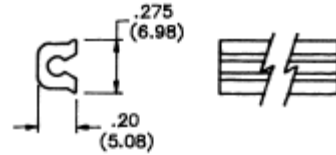

Locking Rail Part Number 1648990-1,
Aluminum alloy, gold anodized finish, 36" length.
Requires cutting to size.

Locking Rail (at 1' interval)
Part Number 1650469-1

End Caps — Zinc die cast, CRS hardware, trivalent chromate finish

End caps secure the modules when screwed into the locking rails providing rigid assembly and a means of mounting assembly to frames, bulkheads, etc. Float mount styles correct for misalignment during mating. Any end cap may be used to mount either pin or socket sides.

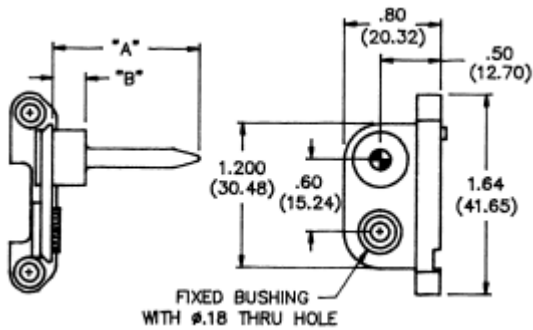

Fixed Mount, Guide Pin
Part Number 6648259-1
A = 1.22 (30.98), B = .275 (6.98)

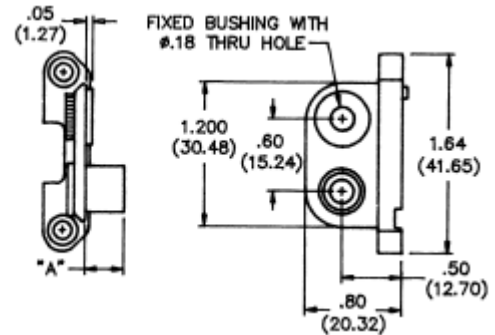

Fixed Mount, Guide Socket
Part Number 6648263-1
A = .175 (4.44)

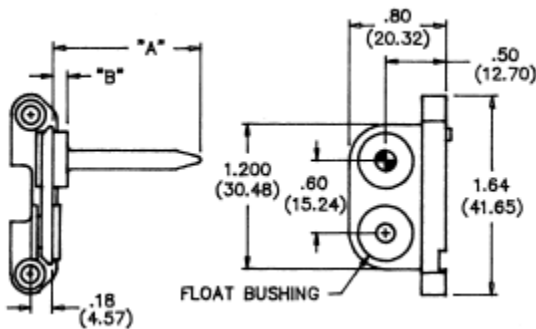

Float Mount, Guide Pin
Part Number 6648251-1
Standard
A = 1.22 (30.98), B = .275 (6.98)
Part Number 6648253-1
L-Module
A = 1.62 (41.14), B = .125 (3.17)

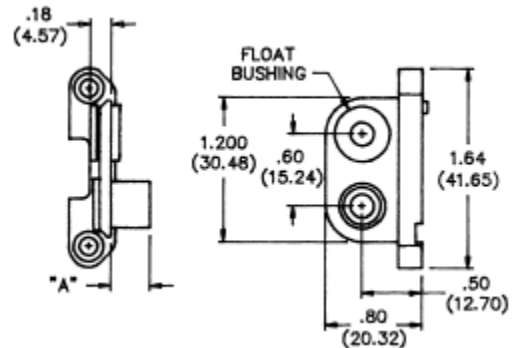

Float Mount, Guide Socket
Part Number 6648252-1
Standard
A = .175 (4.44)
Part Number 6648254-1
L-Module
A = .325 (8.25)

Note: All part numbers are RoHS compliant.

DOMINO Series Connectors (Continued)

**DOMINO Module
Assembly Process**

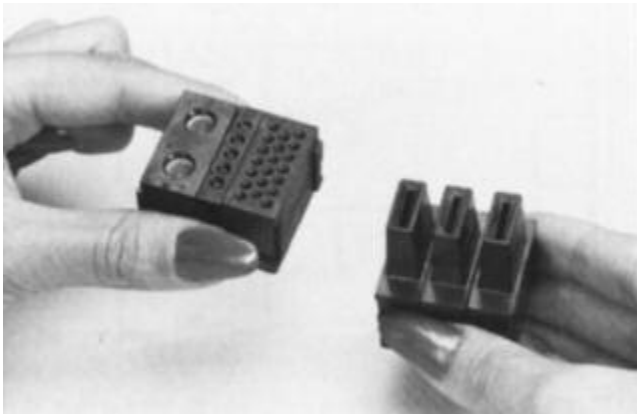

1. Align modules in desired order.

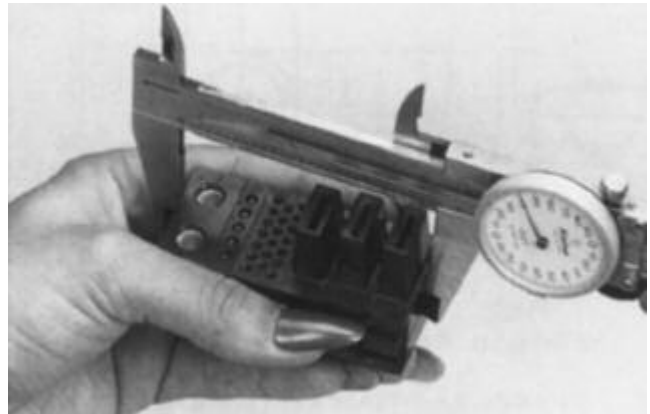

2. Measure length of assembly, and add .100" (2.54mm) to determine overall rail length. Cut rails to length.

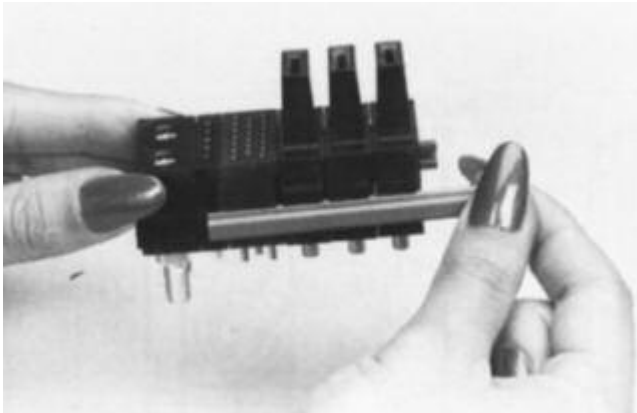

3. Slide locking rails into position on both sides of module assembly via the molded rail tracks.

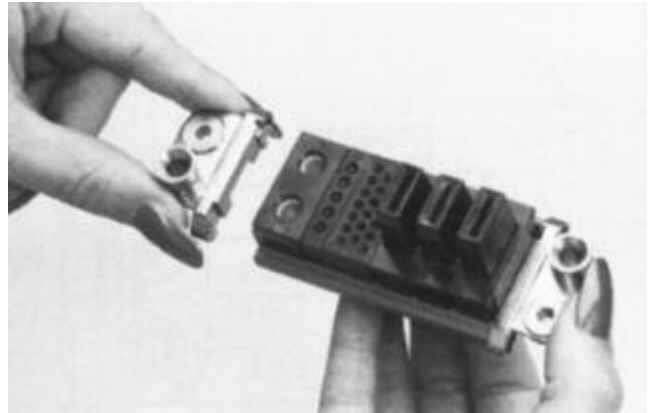

4. Position end caps over locking rail ends and secure using Phillips head screws.